

3.1- A)

Dibuja la sombra del punto A siguiendo la proyección de los rayos de luz natural dados.

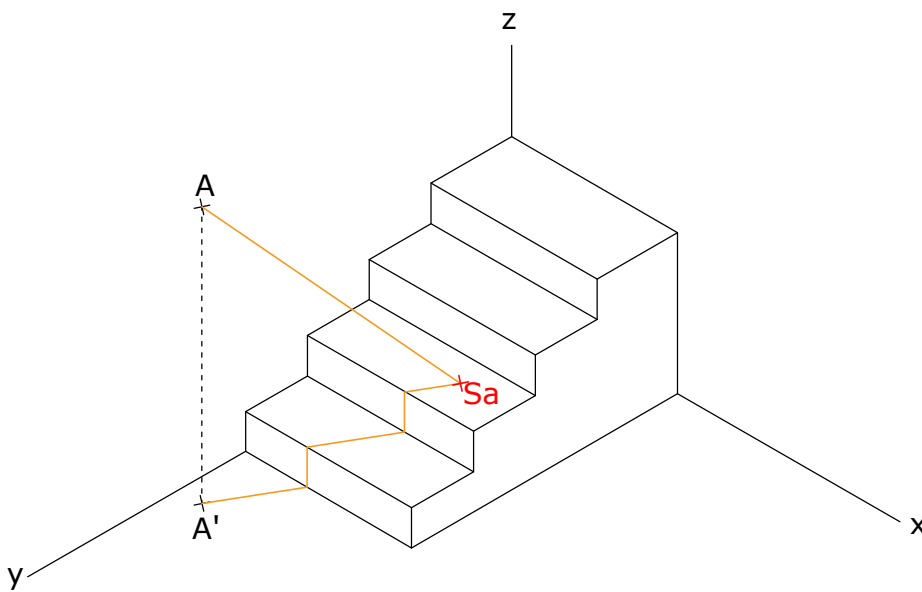
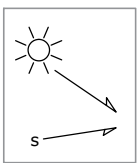
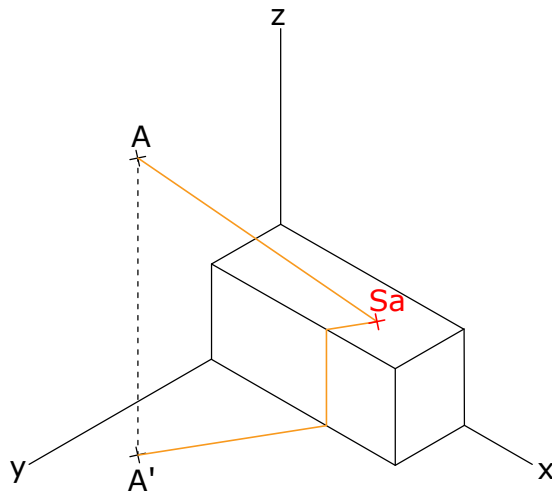
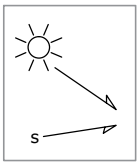
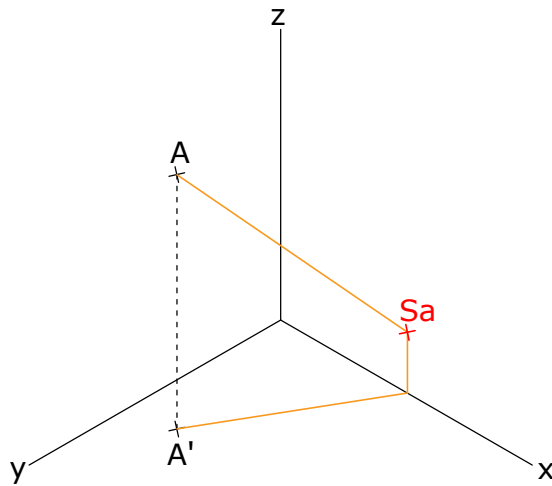
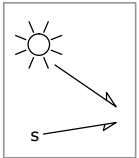

3.1- B)

Dibuja la sombra del segmento AB siguiendo la proyección de los rayos de luz natural dados.

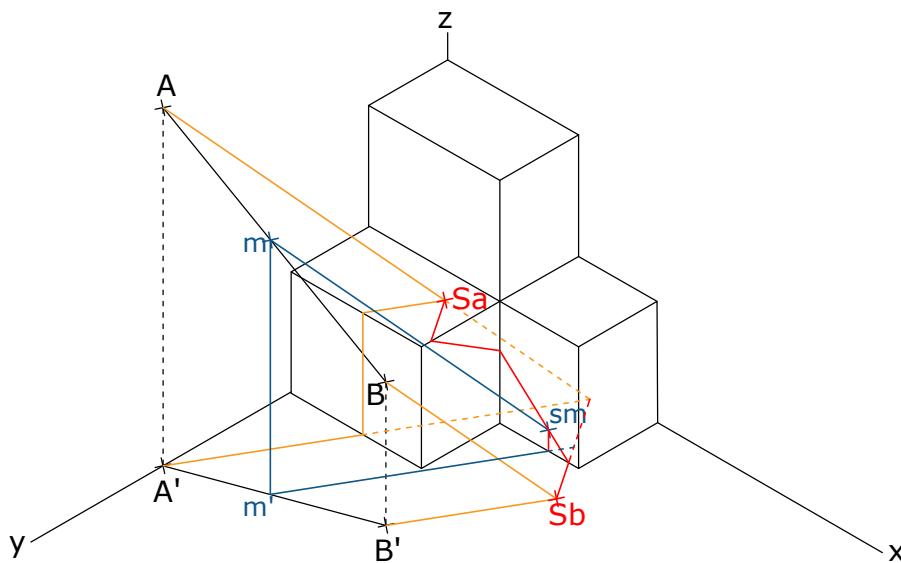
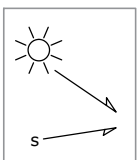
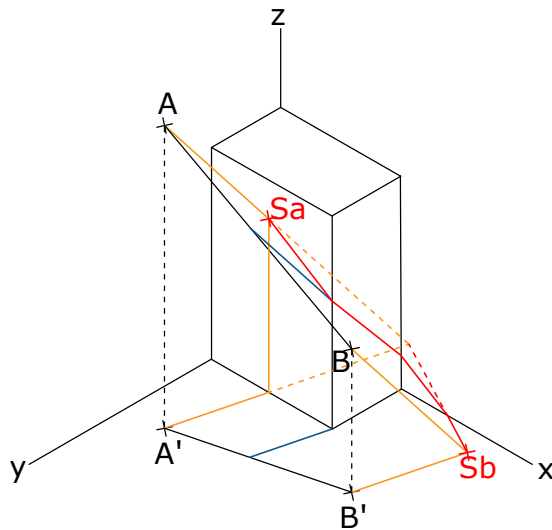
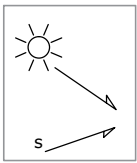
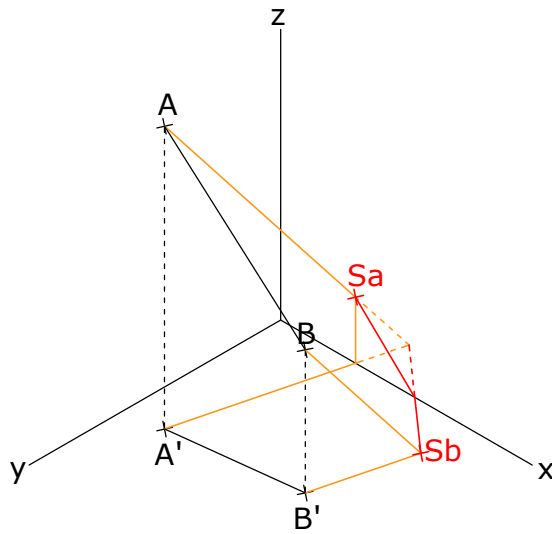
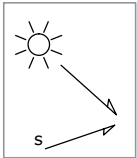

3.1- C)

Dibuja la sombra de la superficie plana poligonal siguiendo la proyección de los rayos de luz natural dados.

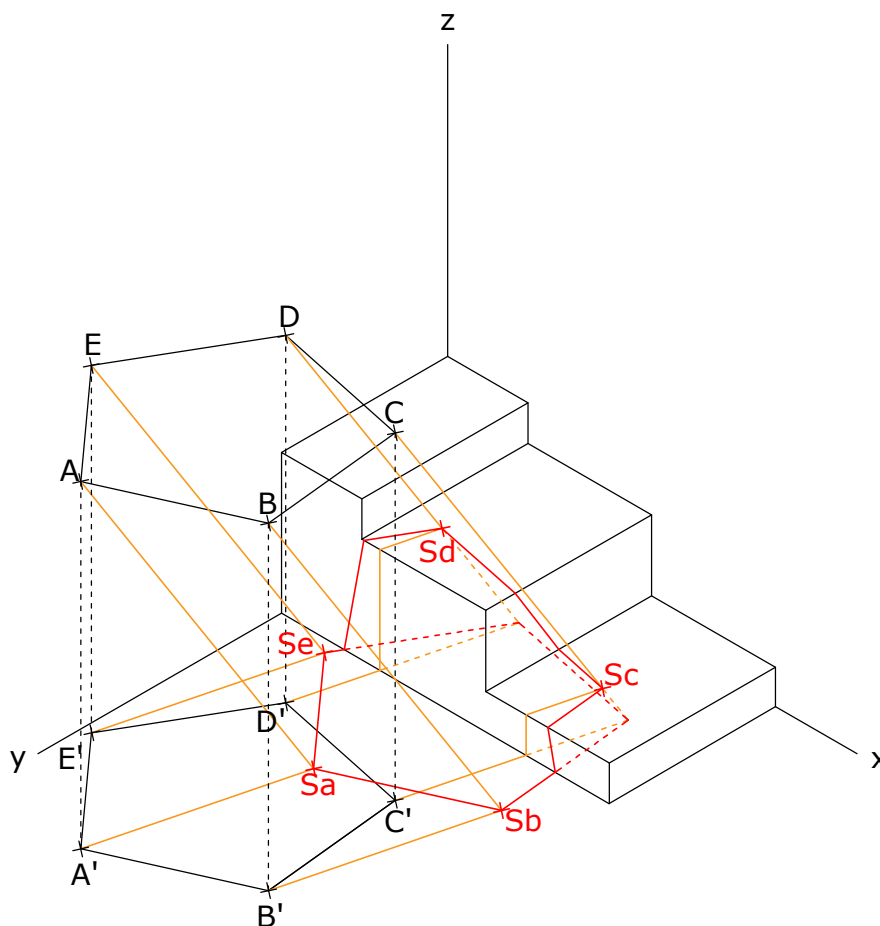
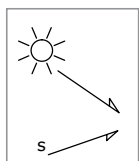
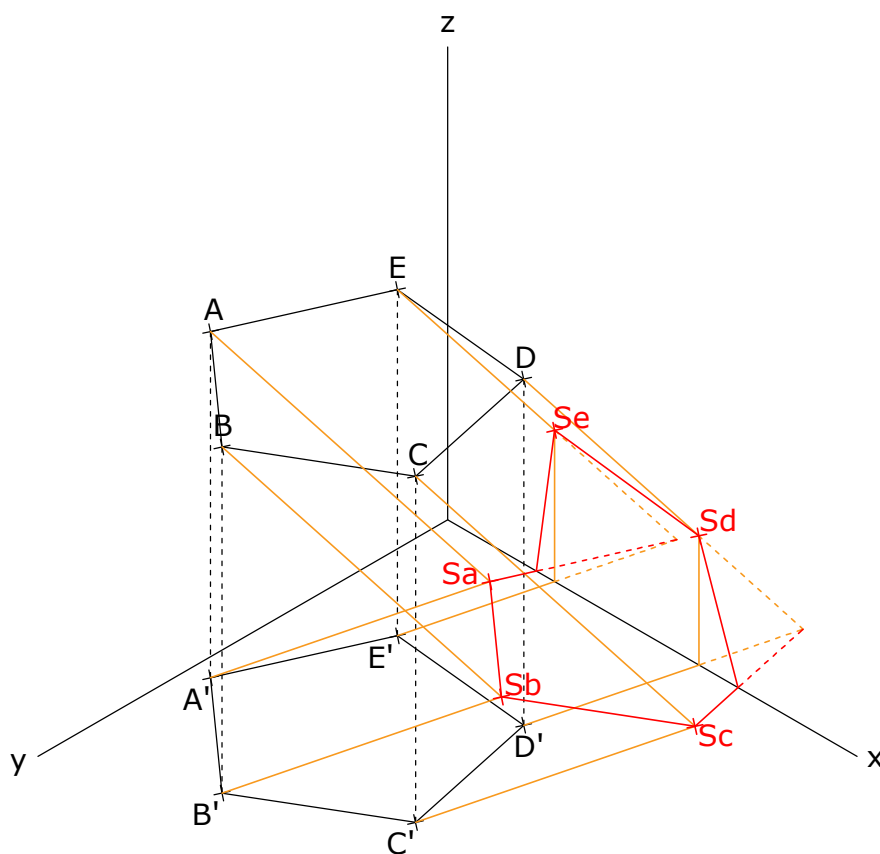
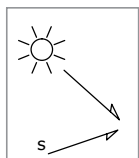

3.1- D)

Dibuja la sombra de la superficie plana circular siguiendo la proyección de los rayos de luz natural dados.

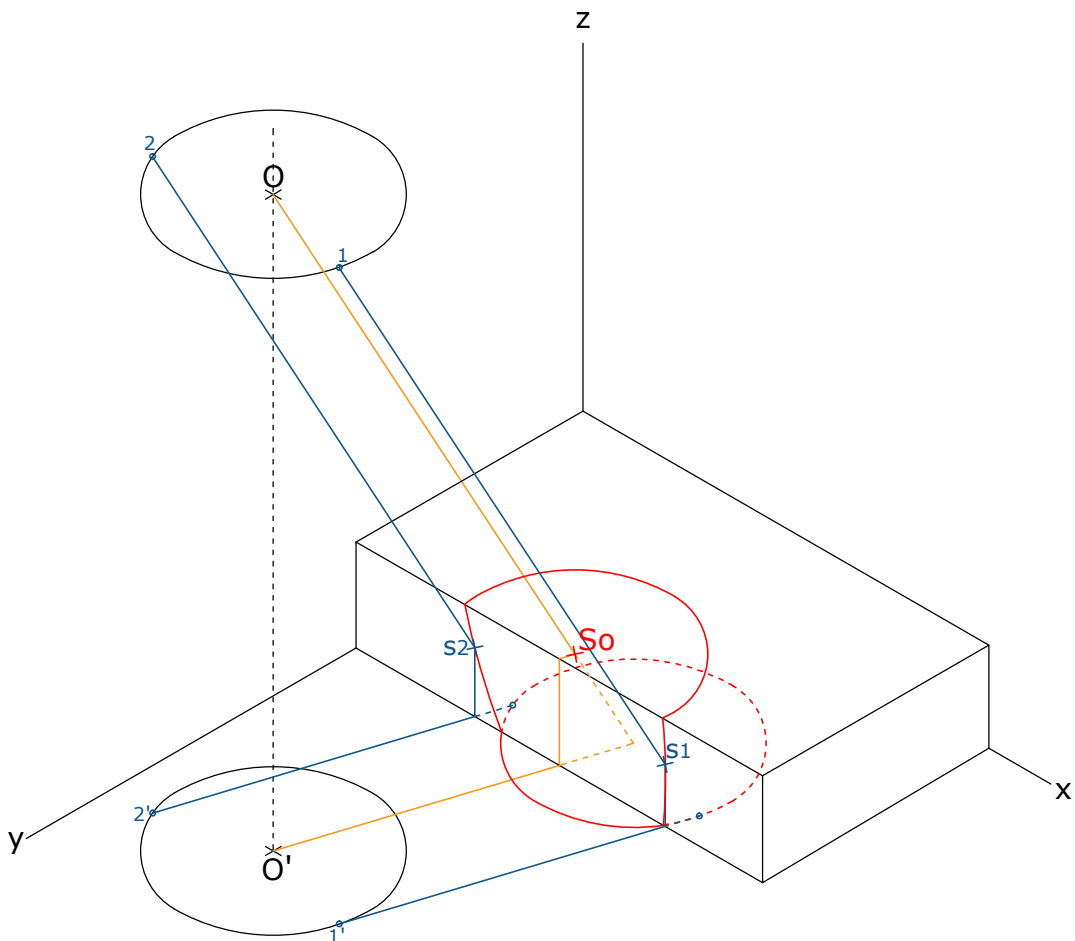
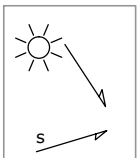
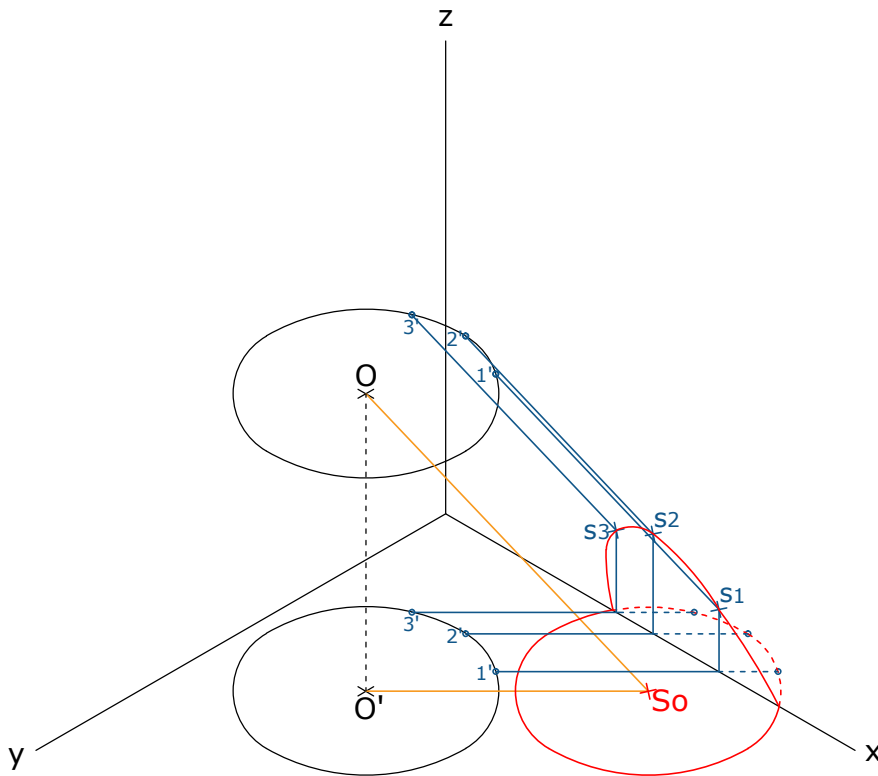
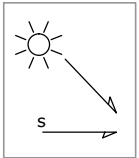

3.1- E)

Dibuja la sombra propia y arrojada de la figura dada siguiendo la proyección de los rayos de luz natural.

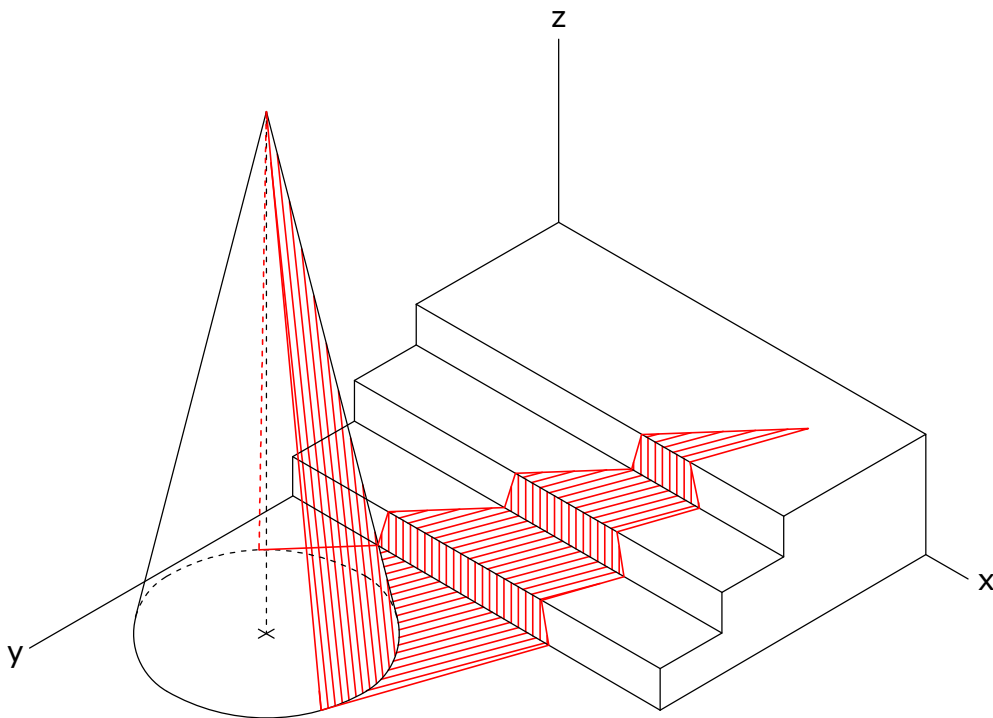
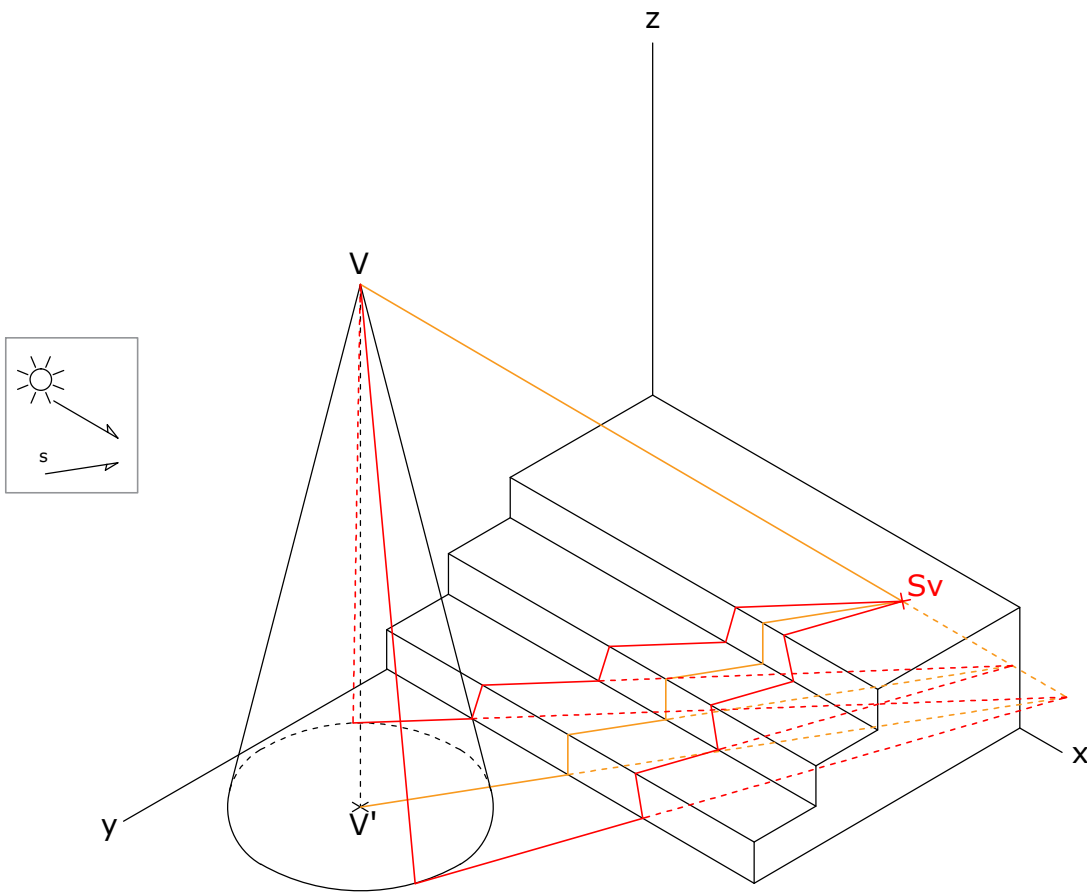

3.1- E)

Dibuja la sombra propia y arrojada de la figura dada siguiendo la proyección de los rayos de luz natural.

