

sección AA'

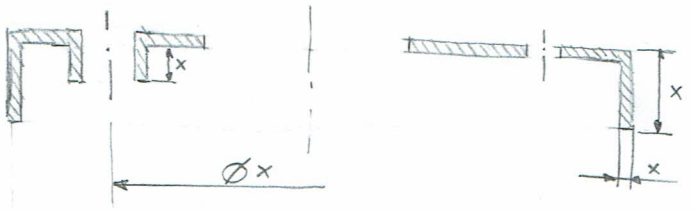

DETALLE B
€ 4:1

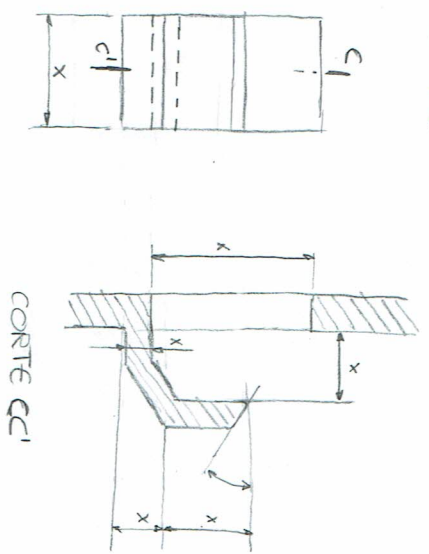

* TOLERANCIAS , REDONDEOS
Y CHATFLANES NO INCLUIDOS

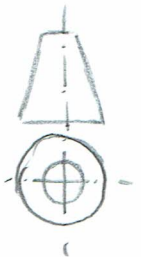

FECHA	DIABUADO	DOVELA	Nº PLANO 01
---	COPIADO	---	
ESCALA	PLANO	ROSETA DE FIJACIÓN	
2.1	PROY.	MANIVELA	

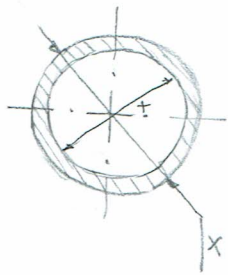
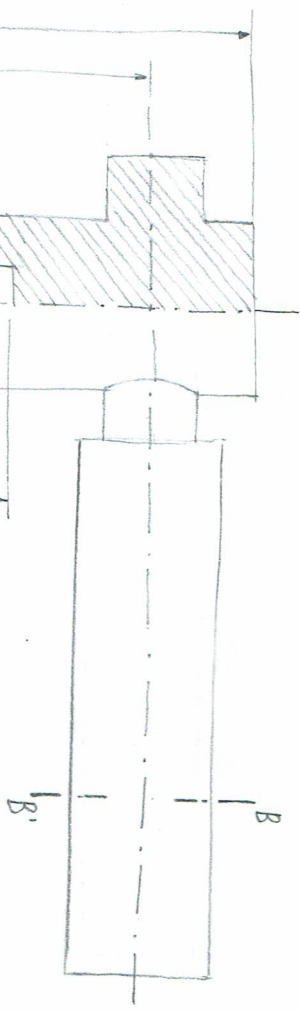
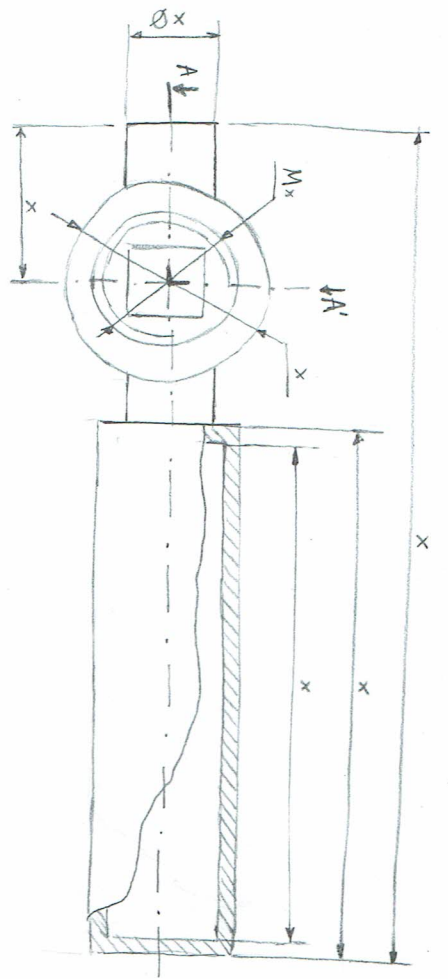

SECCION BB'

* TOLERANCIAS, REDONDEOS Y CHATFLAMES
NO INCLUIDOS

CORTE AA'

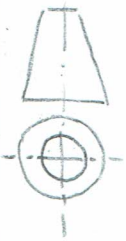

FECHA	DIBUJADO	DOVELA	
ESCALA	COLOREADO		
1:1	PLANO.	MANILLA	Nº PLANO
	PROY.	MANIVELA	02