

# PARÁBOLAS

EXCENTRICIDAD = 1  
LUGAR GEOMÉTRICO

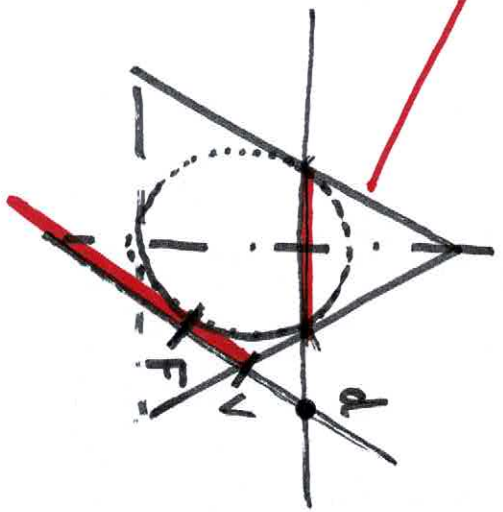
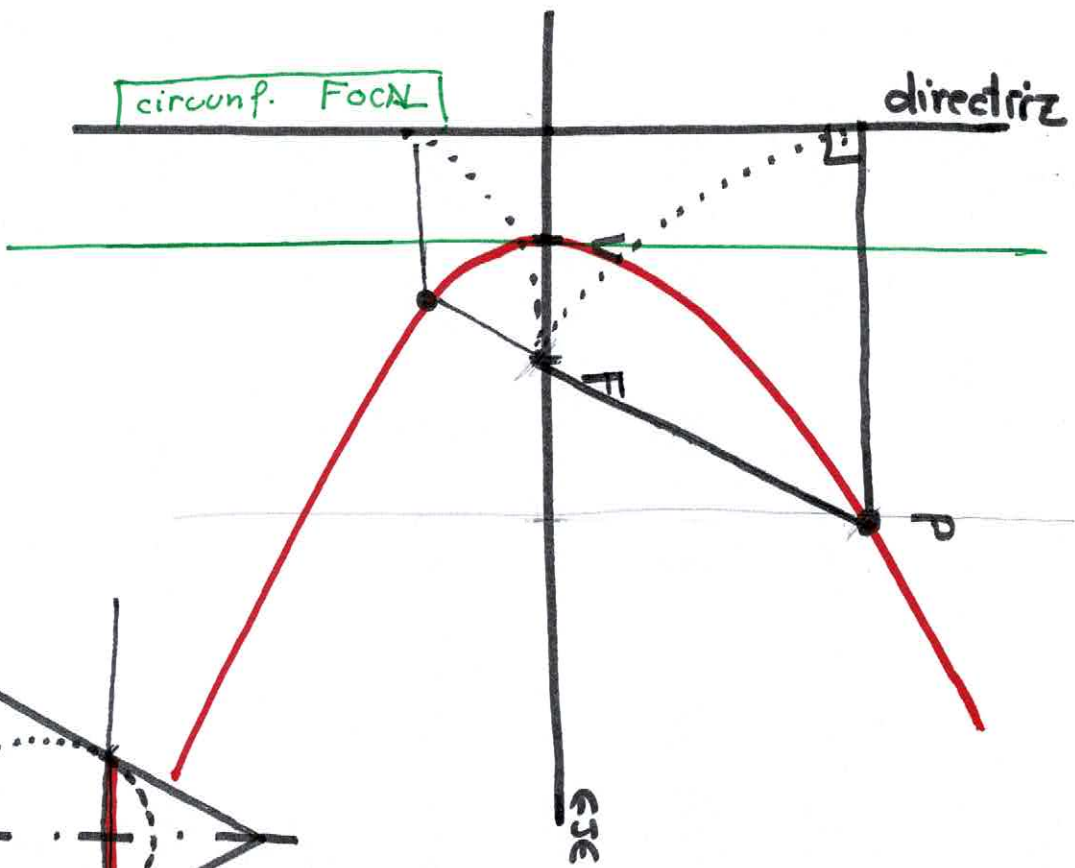
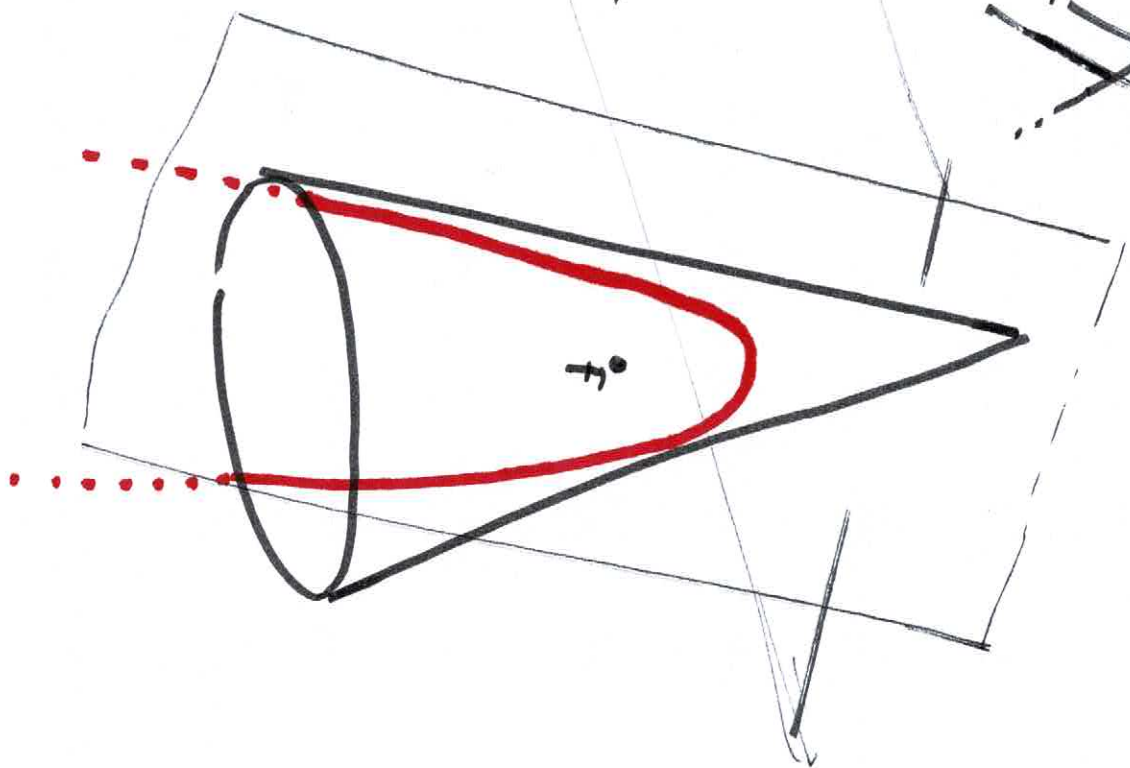

①

MÉTODO  
por  
PUNTOS

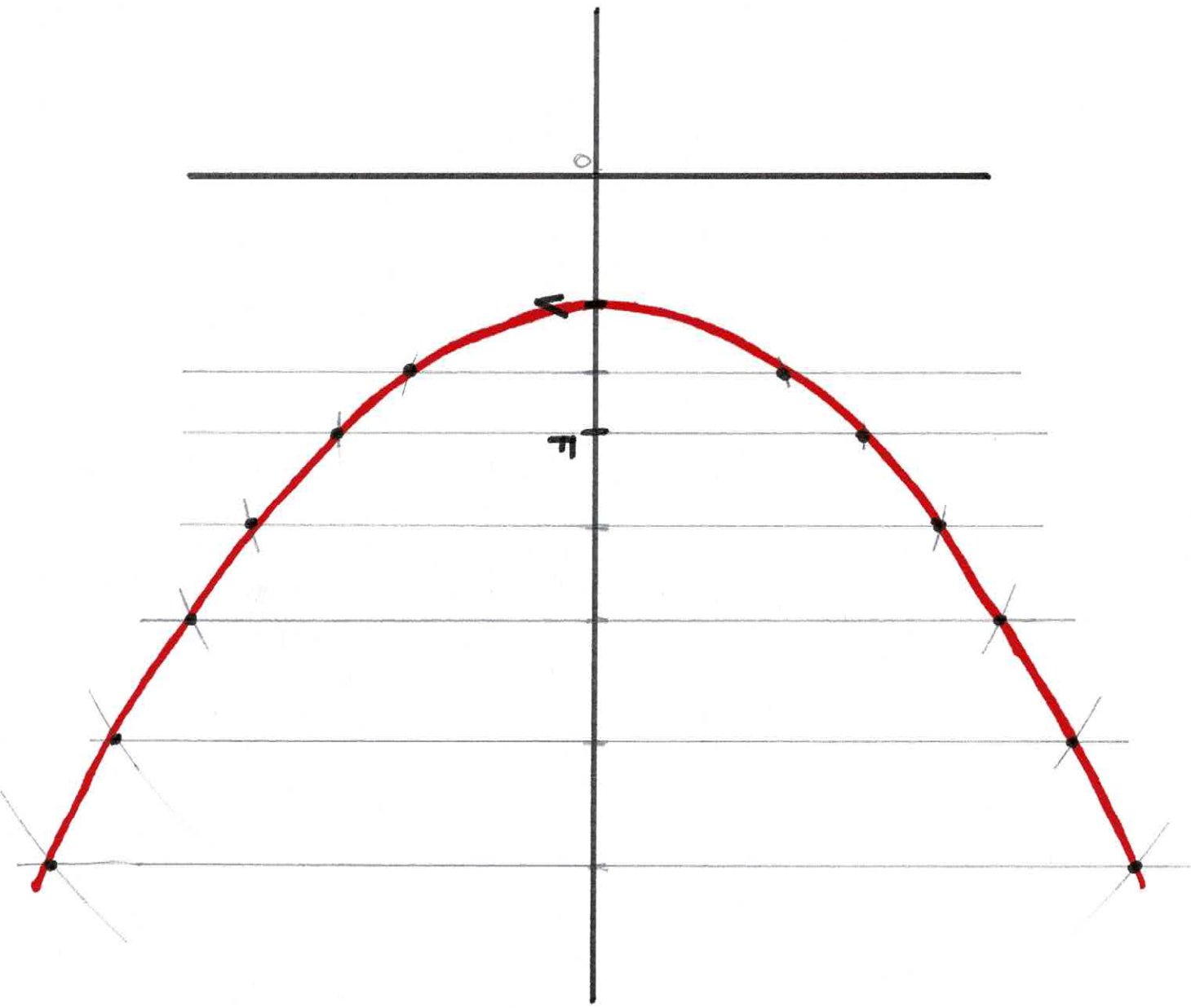

②

# MÉTODO de las SEMICIRCUNFERENCIAS

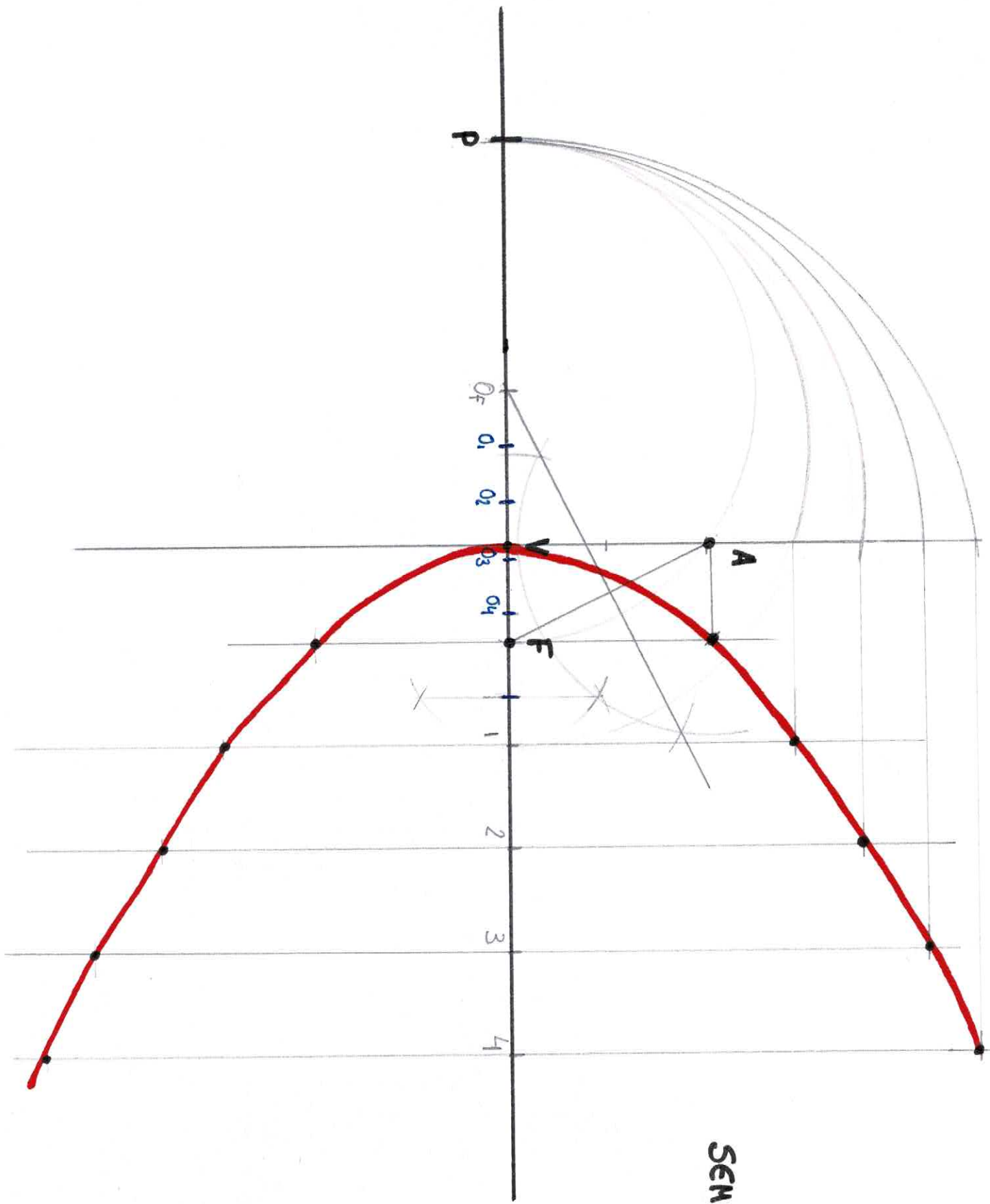

③

1 método } EJE  
          } VÉRICE  
          } P.

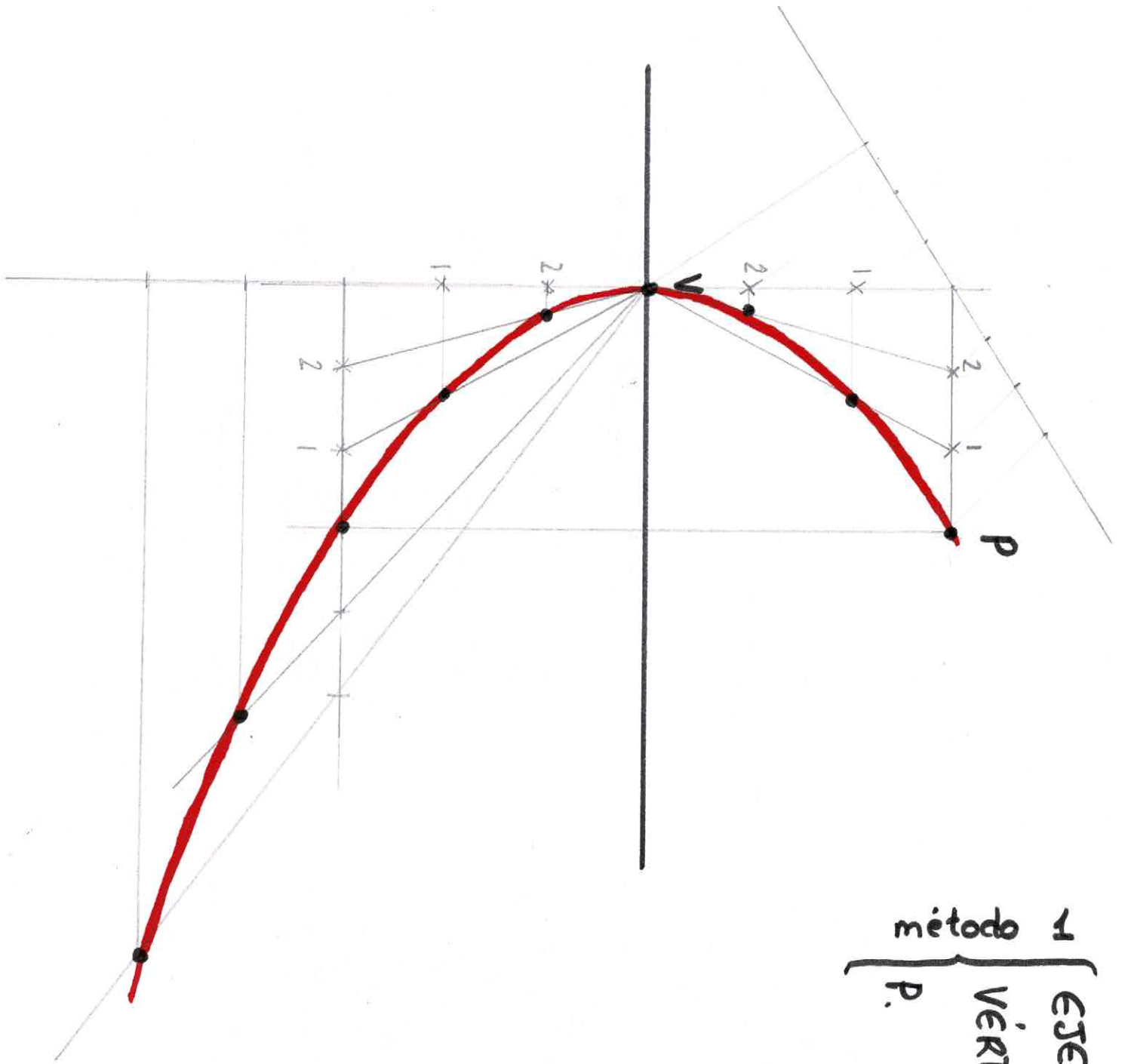

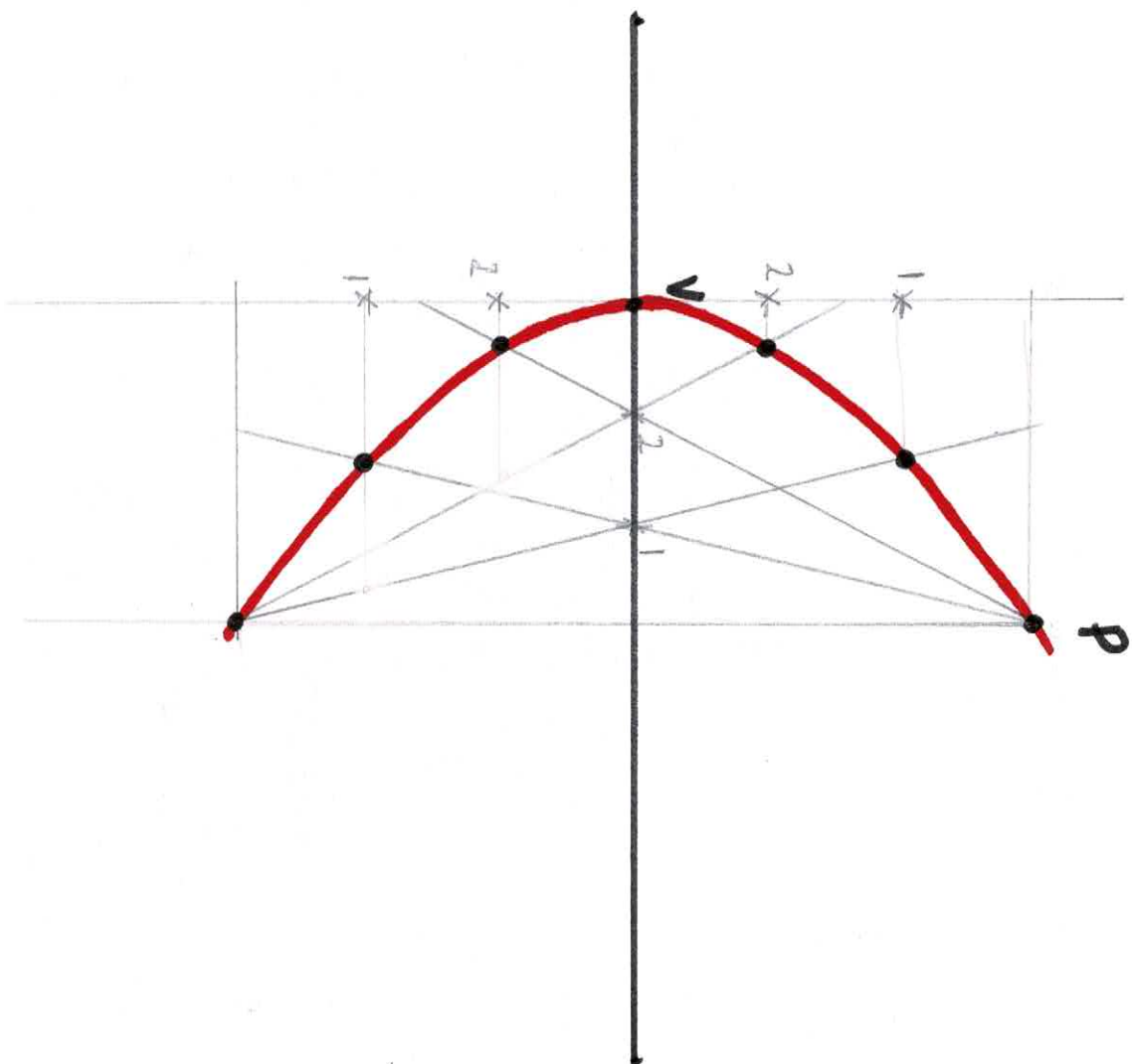

método 2.  
 { este  
 vértice  
 P.

{ 2 PUNTOS  
Foco

⑤

