

3.1- C)

Dibuja la sombra de la superficie plana poligonal siguiendo la proyección de los rayos de luz natural dados.

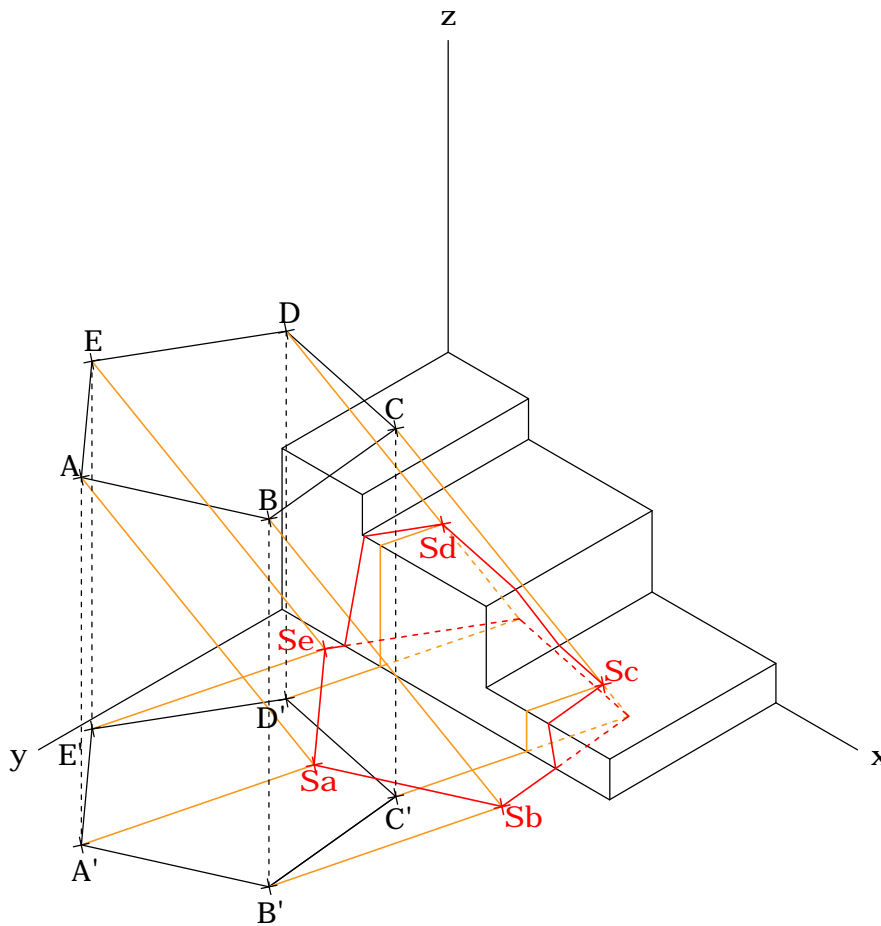
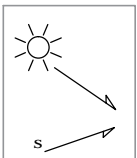
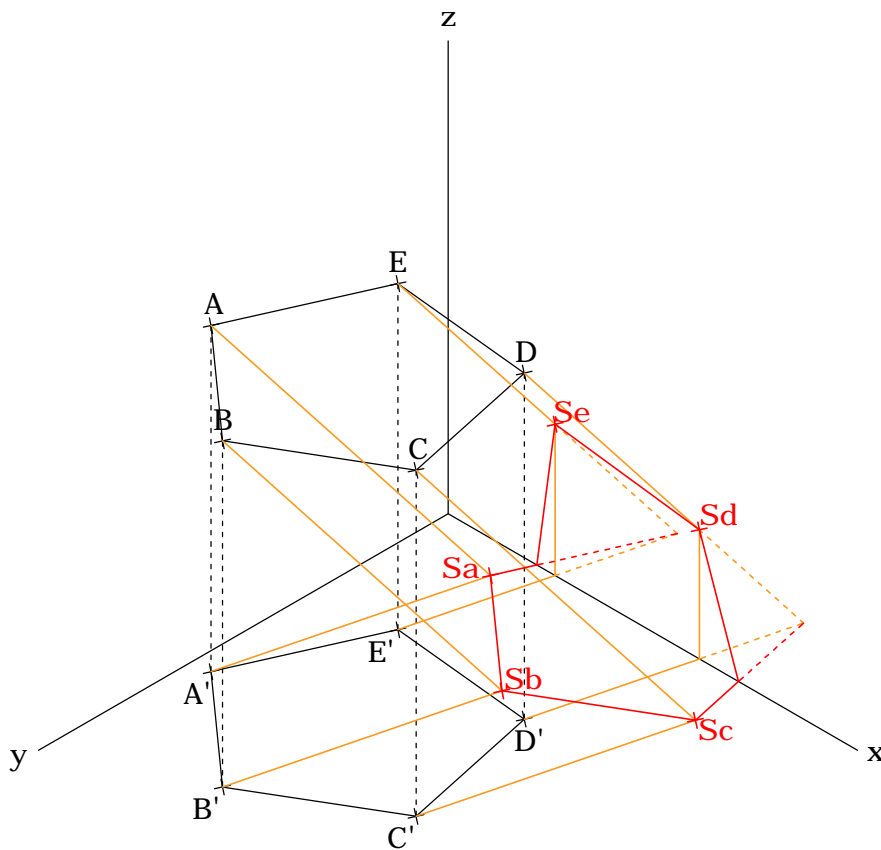
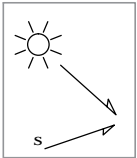

3.1- D)

Dibuja la sombra de la superficie plana circular siguiendo la proyección de los rayos de luz natural dados.

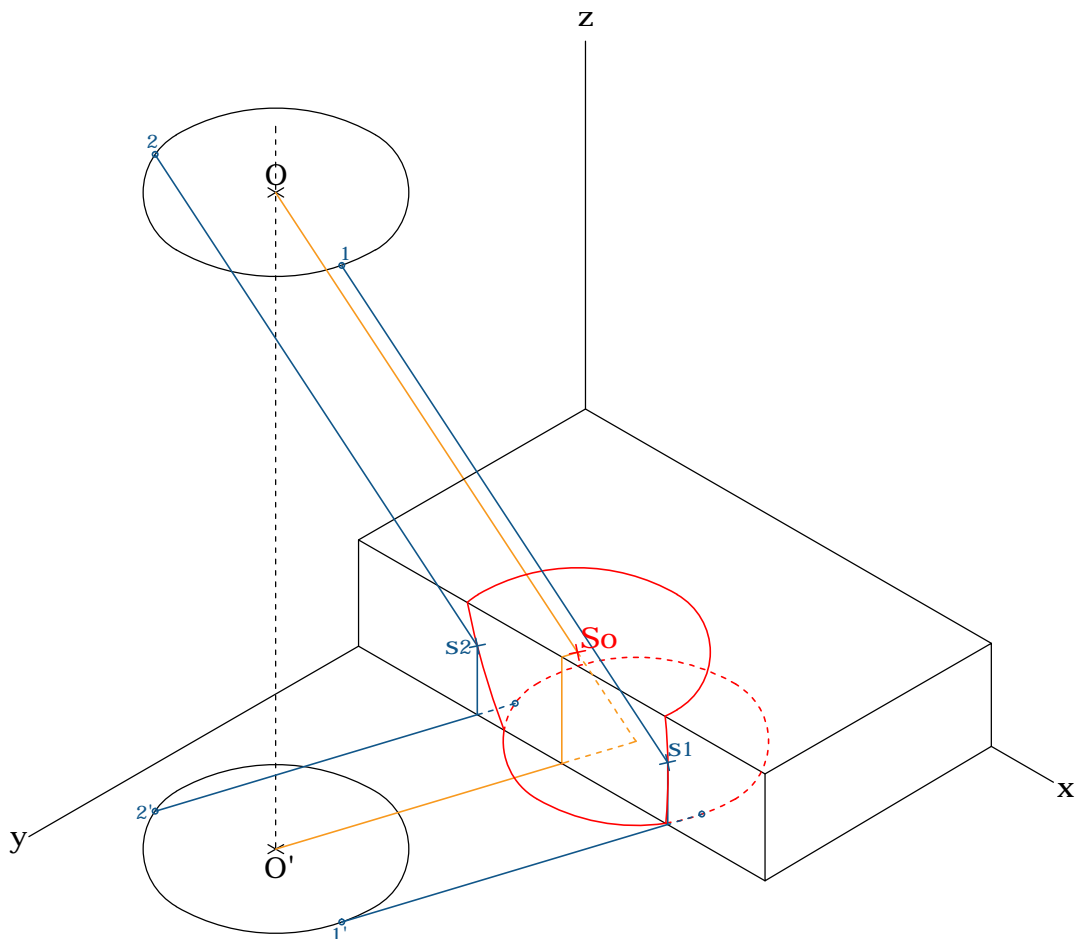
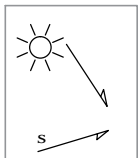
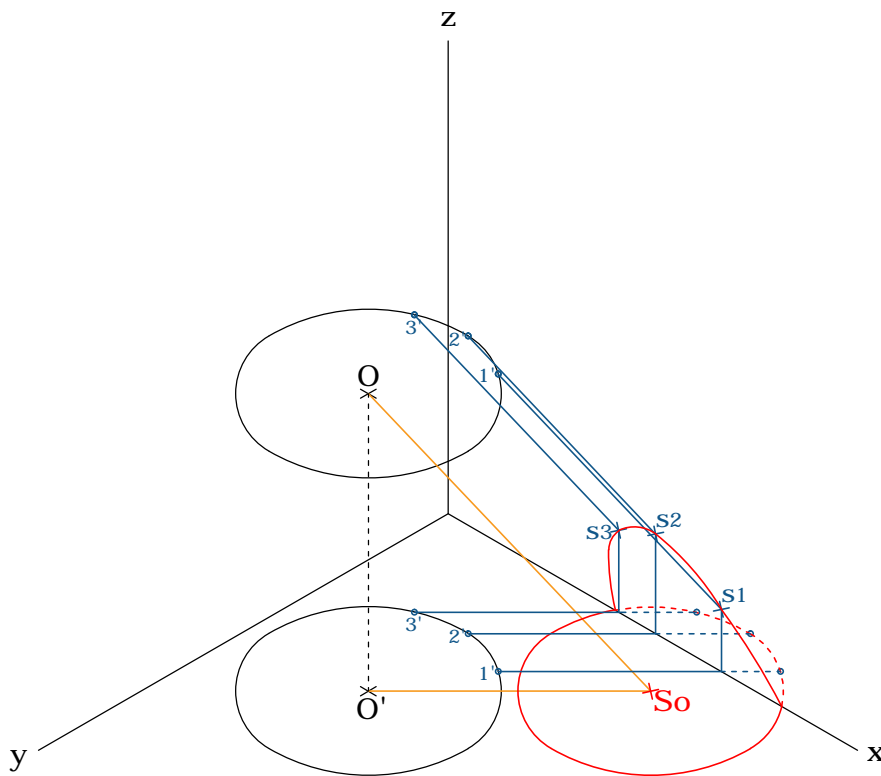
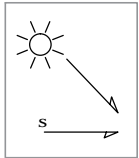

3.3- B)

Encuentra la sombra propia y arrojada de la pieza. Luz paralela.

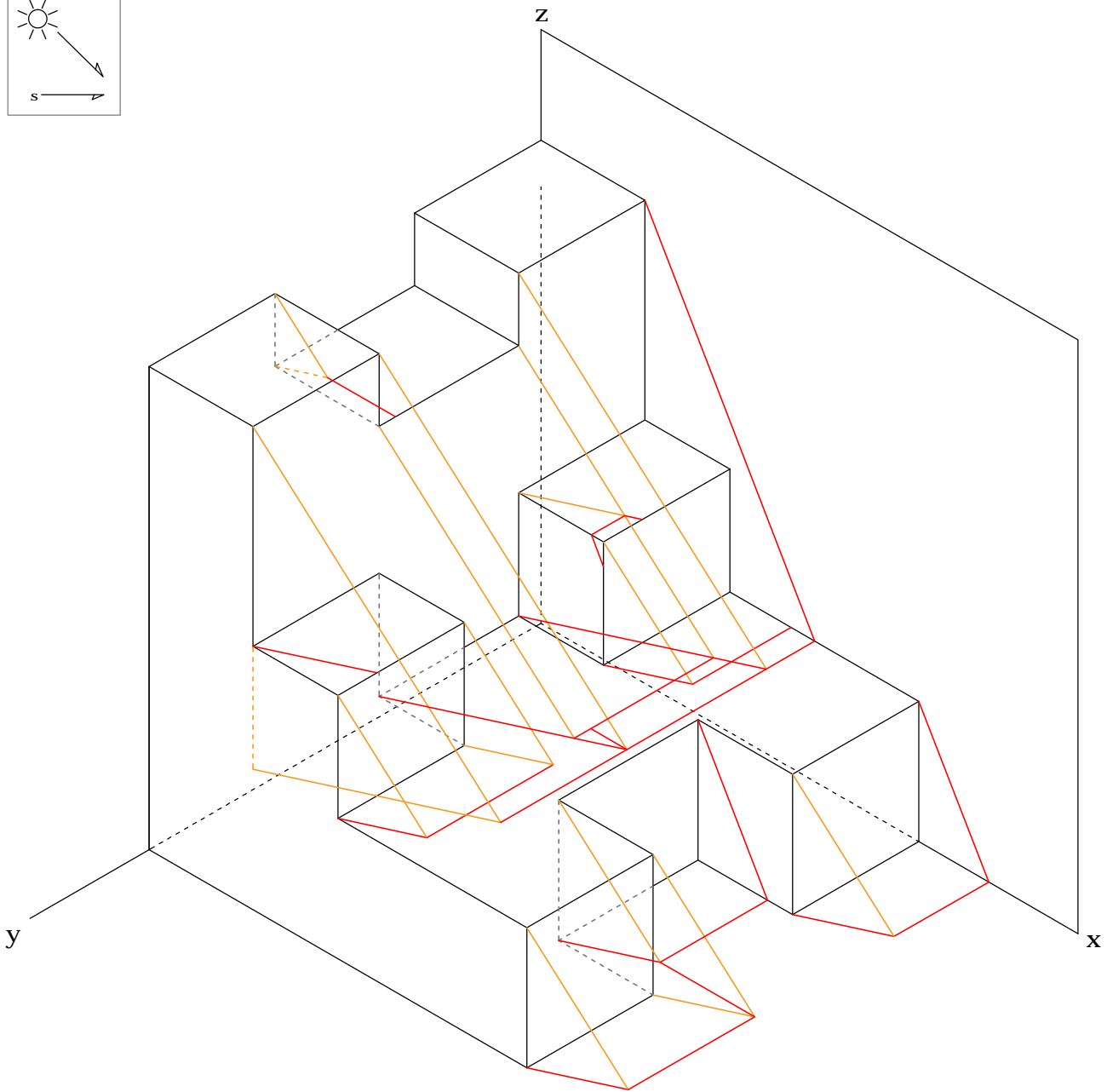
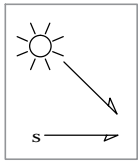

3.3- C)

Encuentra la sombra propia y arrojada de la pieza. Luz paralela.

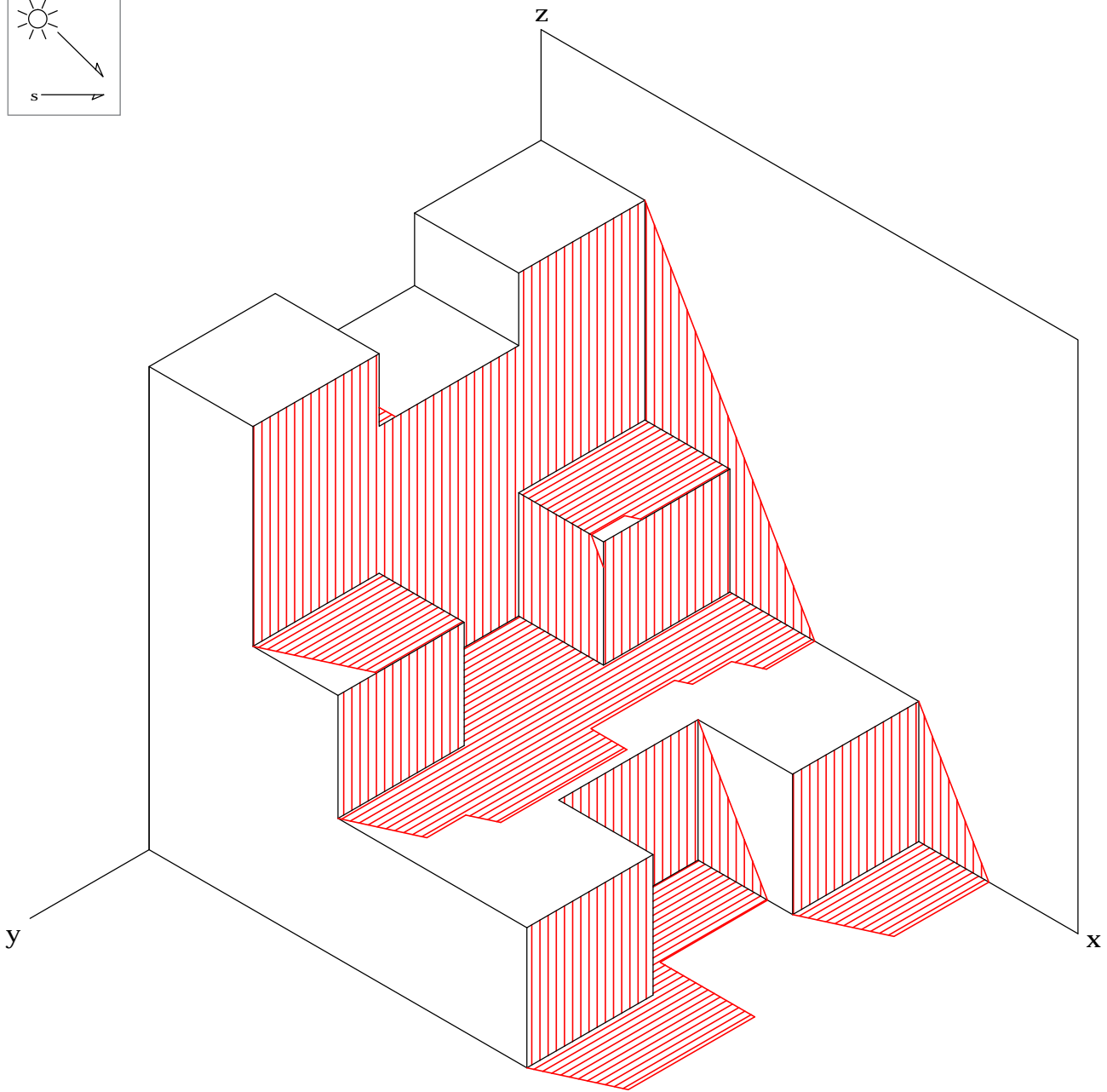
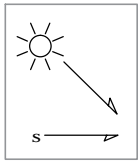

3.3- A)

Encuentra la sombra propia y arrojada de ambas piezas. Luz paralela.

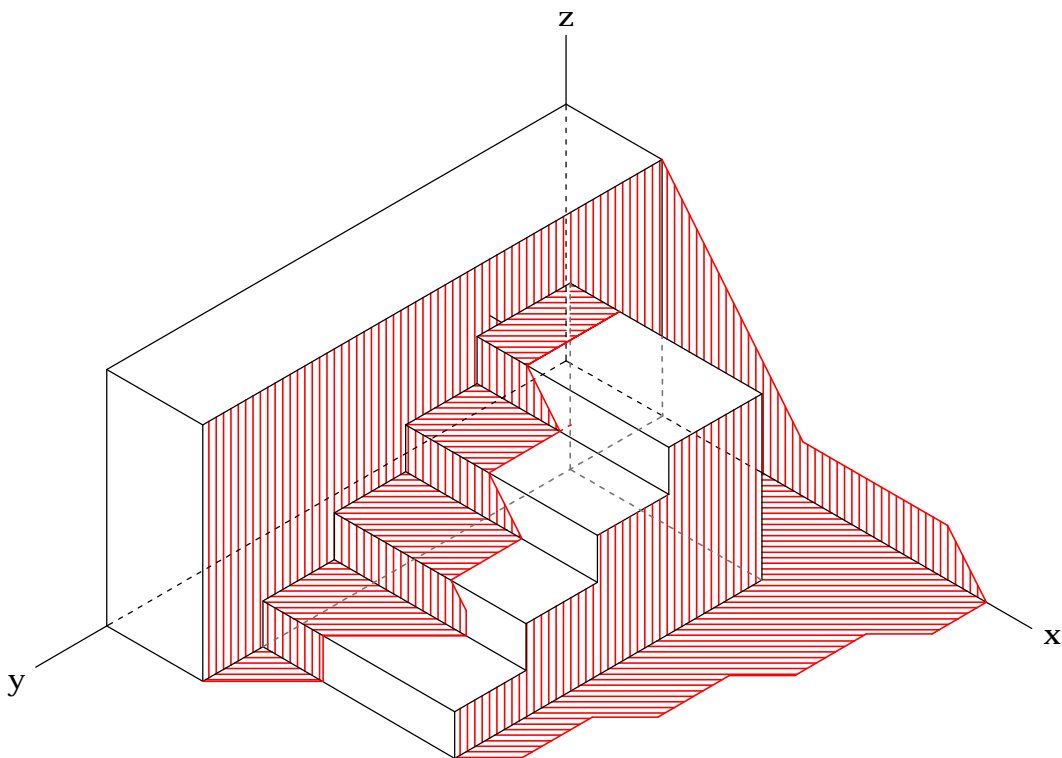
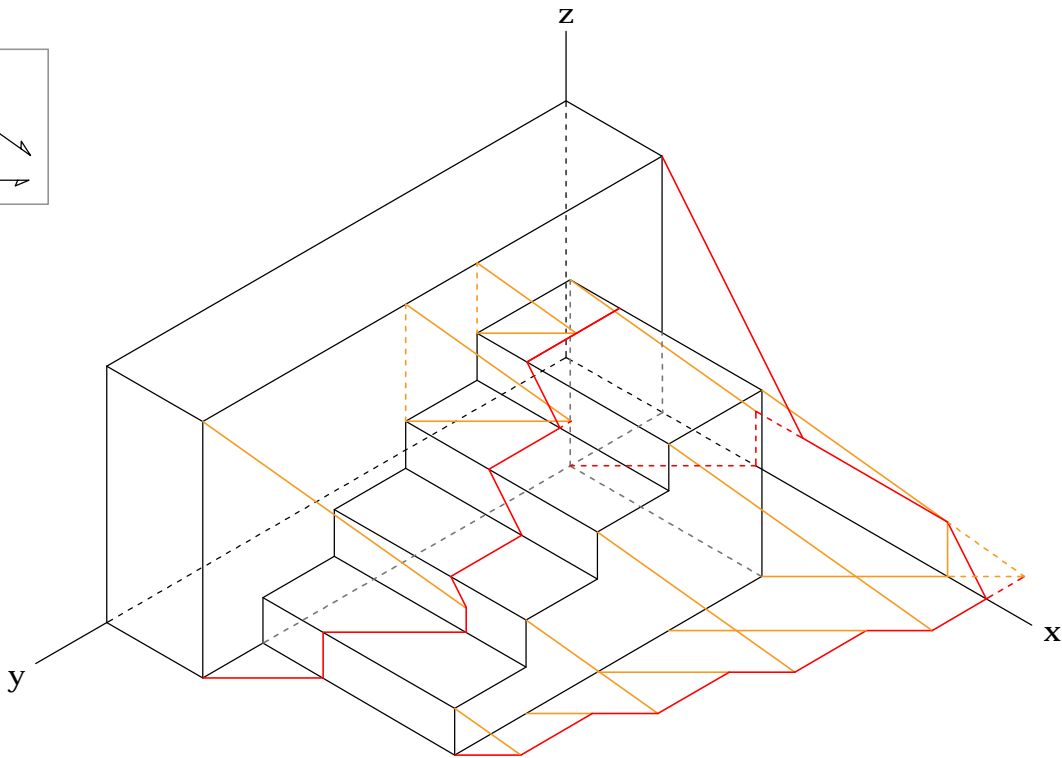
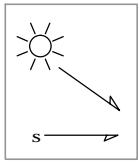

3.3- A)

Encuentra la sombra propia y arrojada de ambas piezas. Luz paralela.

